



- Code: FTM 1007 001
- Description: Desk with frame structure and rectangular legs

Single desks



- ① Worktops available in different finishes and colours
- ② Returns, links and support filing units
- ③ Moulded aluminium supports including rubber pads to hold the worktops
- ④ Aluminium frame available in different finishes
- ⑤ Aluminium levellers with anti-skid pad
- ⑥ Optional accessories suspended on the desk frame

■ DESK-TOP FINISHES

MFC (19 mm)

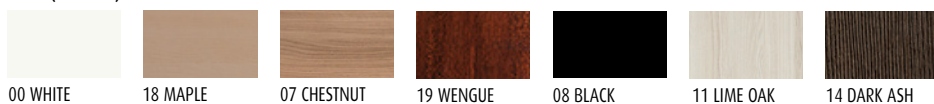

00 WHITE 18 MAPLE 07 CHESTNUT 19 WENGUE 08 BLACK 11 LIME OAK 14 DARK ASH

* Finishes specific for Desks
with return supported by pedestal unit

Compact Laminate (13 mm)



30 WHITE 35 MAPLE 36 CHESTNUT 39 WENGUE 38 BLACK

(See finishes cards)

Laminated security glass
(5+5/6+6 mm)



50 FROSTED 51 CLEAR 56 BLUE 59 BLACK 52 WHITE EXTRA CLEAR

Tempered security glass (10 mm)

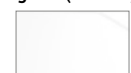

52 WHITE EXTRA CLEAR

Becnh desks



- ① Worktops available in different finishes and colours
- ② Optional accessories suspended on the electrification channel middle beam
- ③ Cable basket suspended on the desk beams. Cable access from the worktop
- ④ Moulded aluminium supports including rubber pads to hold the worktops.
- ⑤ Aluminium frame available in different finishes
- ⑥ Aluminium levellers with anti-skid pad

■ **FRAME**

Moulded aluminium legs and extruded aluminium beams. Five different finishes: Silver, White or Black coating, Polished or Chromed

■ **LEG SUPPORTS**

Moulded aluminium **leveller**. Chromed. Each leveller includes anti-skid pad



White coating



Silver coating



Polished



Chromed



Black



Leveller - desk height: 74,5 cm

■ ELECTRIFICATION SYSTEM

Full length cable channel with large capacity for cables. Easy access to the cables from the worktop.

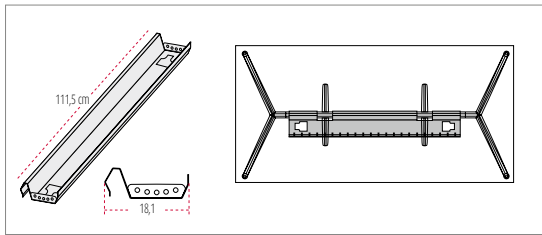
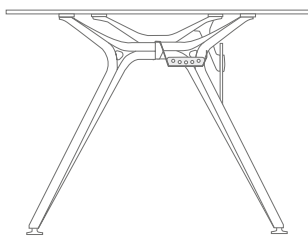

111,5 cm Channel for individual use 180 and 200 cm desks

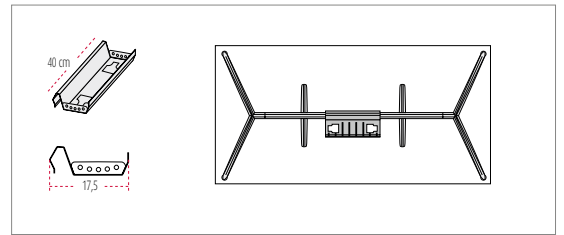

40 cm Channel for individual use 160, 180, 200 and 220 cm desks



Channel for double use 160 and 180 cm desks. **Optional**

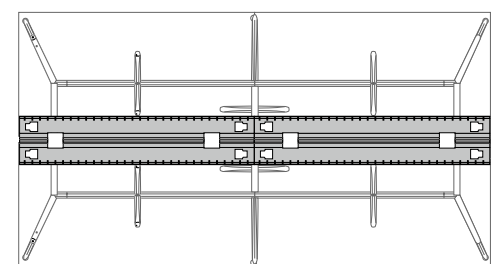

Flip up aluminium door and metal cable box for cable access. It provides effective cable management solutions. Perfect in workplaces with several users.

Technical features:

- Large capacity for cables.
- Maximum accessibility and socket.
- Optimize work surface.
- Polished flip up door and trim.



Flip up door and metal box

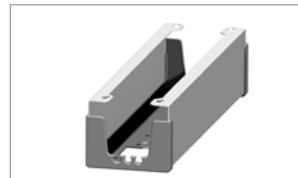

For Access wiring "W"

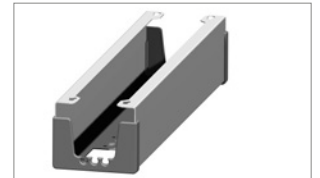

For Access wiring "Y"

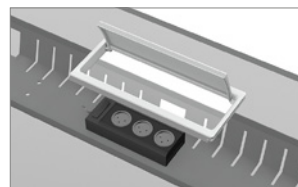

Access wiring "W"

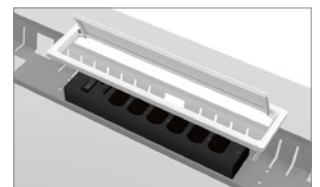

Access wiring "Y"

Metal container 1,2 mm thickness for connections. It provides maximum accessibility, optimising the work surface. Recommended solution for positions that have several different users.

Full length cable tray. A large steel cable tray under the worktops. Easy to access thanks to the aluminium flip up doors fixed to the central beam.

Technical features:

- Maximum capacity.
- Easy access to the cable connectors for the users as well as the technicians.
- Recommended for large projects where intensive cable capacity is required.



Full length cable tray

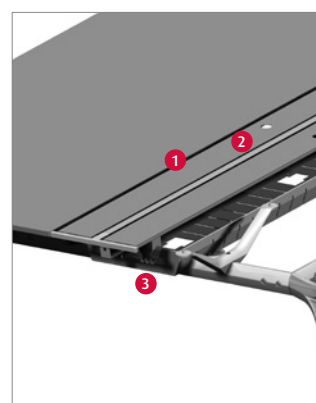

- ① Flip up doors to access to the connections
- ② Aluminium middle beam provides fixing support to the flip-up door as well as screens
- ③ A full length steel cable tray under the worktops fixed to the frame

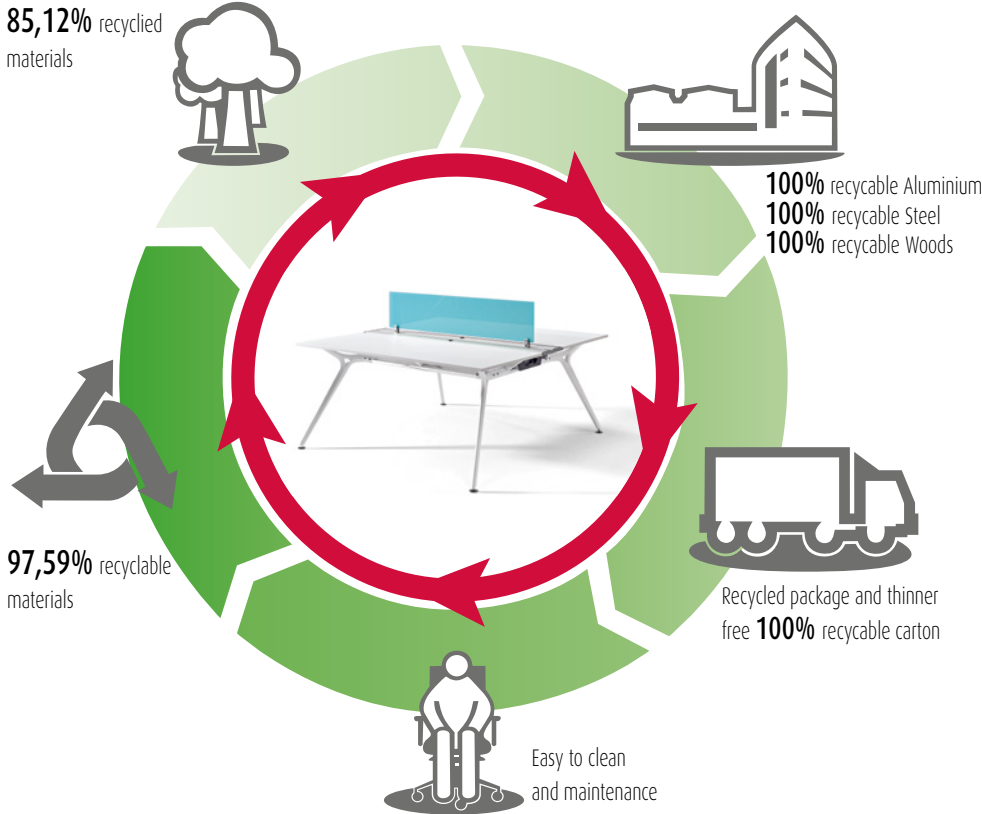

MATERIALS

ARKITEK has been designed to be manufactured with recycled materials 85,12%, danger substances such as chrome, mercury or cadmio are not used in big quantity. Recyclable Aluminium, Steel or Woods 100%. Organic volatile Components. Packages manufactured with recycled carton. Ink thinner free.

PRODUCTION

Energy use is optimized during the production process. Minimum environmental impact. Last generation technological system in coating processes. Painting that have not been used is recovered to use it again. Zero COVs emissions and other contaminant gas. Close water circuit to clean the metals. Heat recovery. Automatic manufacture systems. Cut process is planned.

TRANSPORT

Optimum packaging to reduce space in transport and save energy.

USE

Long lasting use. Spare parts and replacements available. Easy to clean and maintenance.

DISPOSAL

97,59% recyclable. Easy and quick to split **ARKITEK** components. Packages are reuse by our supplier to avoid waste generation. Carton used in packages is recyclable.

CERTIFICATES AND REFERENCES

The different programmes get points in different environmental categories to get the LEED certificate (sustainability, material and resources, water, energy and atmosphere, inner environment quality, innovation and design).



The mark of responsible forestry



PEFC Certificate



EN ISO 14006:2011
ECODESIGN Certificate



UNE-EN ISO 9001:2008
ISO 9001 Certificate



UNE-EN ISO 14001:2004
ISO 14001 Certificate



E1 by EN 13986 Certificate



ACTIU TECHNOLOGICAL PARK
project certified as **LEED® GOLD**
by U.S. Green Building Council 2011
Leadership in Energy & Environmental Design

■ SPINE STORAGE FOR DESKS SUPPORTED BY SPINE STORAGE UNIT



■ TECHNICAL FEATURES

- **Frame:** The frame is made of 19 mm melamine finished in white. 180 x 44 x 61 cm - Compartment using one side.
- **Shelves:** Interior shelves 19 mm melamine finished in white.
- **Top cover:** Top cover in 25 mm melamine, veneered soft edges for added safety and durability, finished in white, black or chestnut, meeting the standards of abrasion and scratch resistance.
- **Front:** Spine has two models of reversible fronts, combining between them:
- **Sliding melamine** 16 mm door finished in white, black or chestnut, with handle and lock.
- **Filing drawer** with metal tray and melamine 16 mm front, finished in white, black or chestnut, with handle and lock.
- **Space Electrification:** Hollow interior for continuous electrification with access to it from the top using rounded acces.
- **Feet:** Steel tube section 35 x 35 mm and width 1,5 mm with leveler and non slip. It has a recessed central leg which confers increased stability.

■ MODULE SPINE SIZES

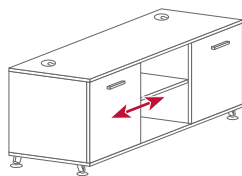
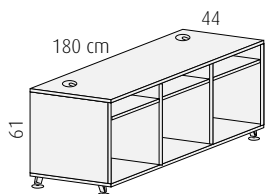

Module Spine with sliding doors

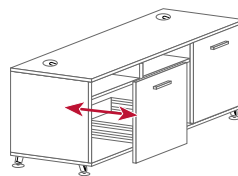

Module Spine with Filing drawer

■ DESK-TOP FINISHES

MFC



Compact Laminate



(See finishes cards)

Recycled materials

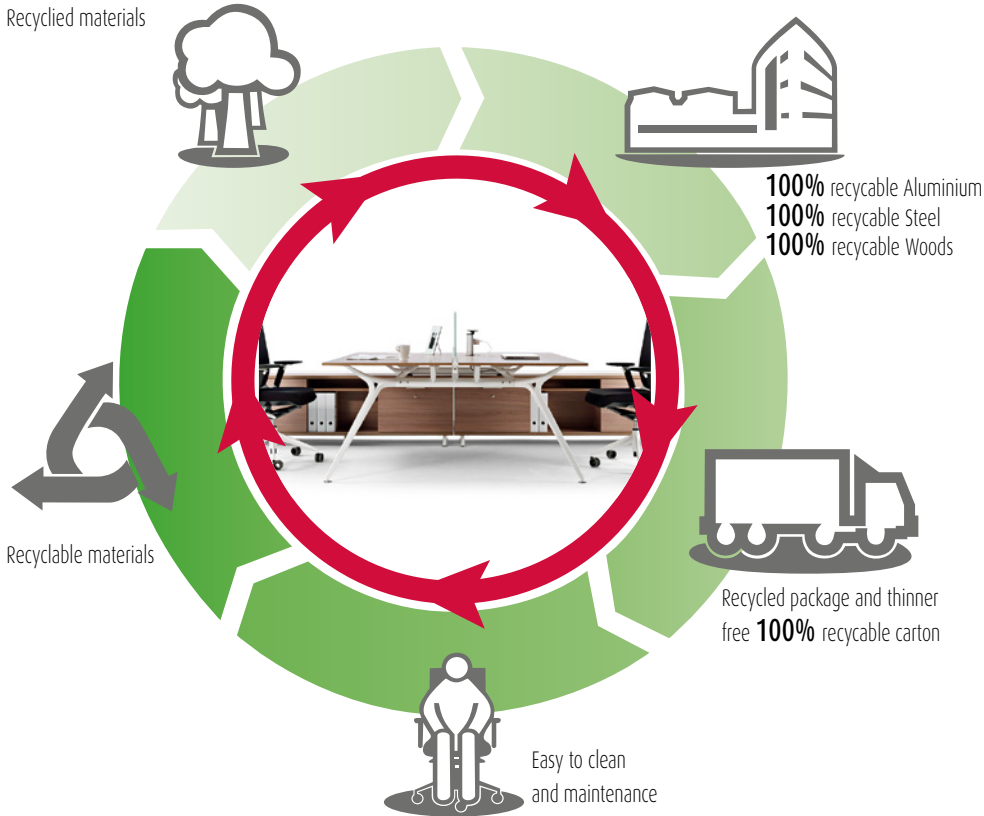

 **MATERIALS**

ARKITEK has been designed to be manufactured with recycled materials, danger substances such as chrome, mercury or cadmium are not used in big quantity. Recyclables Aluminium, Steel or Woods 100%. Organic volatile Components. Packages manufactured with recycled carton. Ink thinner free.

 **PRODUCTION**

Energy use is optimized during the production process. Minimum environmental impact. Last generation technological system in coating processes. Painting that have not been used is recovered to use it again. Zero COVs emissions and other contaminant gas. Close water circuit to clean the metals. Heat recovery. Automatic manufacture systems. Cut process is planned.

 **TRANSPORT**

Optimum packaging to reduce space in transport and save energy.

 **USE**

Long lasting use. Spare parts and replacements available. Easy to clean and maintenance.

 **DISPOSAL**

Recyclable. Easy and quick to split **ARKITEK** components. Packages are reuse by our supplier to avoid waste generation. Carton used in packages is recyclable.

CERTIFICATES AND REFERENCES

The different programmes get points in different environmental categories to get the LEED certificate (sustainability, material and resources, water, energy and atmosphere, inner environment quality, innovation and design).



The mark of responsible forestry



PEFC Certificate



EN ISO 14006:2011
ECODESIGN Certificate



UNE-EN ISO 9001:2008
ISO 9001 Certificate



UNE-EN ISO 14001:2004
ISO 14001 Certificate



E1 by EN 13986 Certificate



ACTIU TECHNOLOGICAL PARK
project certified as LEED® GOLD
by U.S. Green Building Council 2011
Leadership in Energy & Environmental Design

■ ERGONOMICS

ARKITEK available for all type of users. Perfect for any need and keep user's posture in a natural way without any manual adjustment.

■ STANDARDS

ARKITEK has passed tests done in our technical department as well as the tests done in **AIDIMA** the Technological Institute for furniture. The tests correspond to UNE standards and office desks:

- **UNE: EN 527-1:2003**. Office Furniture. Desks. Part 1: Dimensions.
- **UNE: EN 527-2:2003**. Office Furniture. Desks. Part 2: Mechanical security requirements.
- **UNE: EN 527-3:2003**. Office Furniture. Desks. Part 3: Test to determine stability and structure resistance.

■ ECOLOGY

ENERGY SAVING

The new technological production system included, reduce the energy resources used to manufacture each component. Materials are very well used to avoid wastes.

RECYCLED AND RECYCABLE MATERIALS

ACTIU environmental policy opts to use recycled materials in those components where functionality and lasting is not a condition. Materials used in **ARKITEK** such as Aluminium, Steel or Wood are totally recyclable.

SUSTAINABLE CERTIFICATE

ACTIU has **PEFC and FSC** certificate to proof that the wood used in our products comes from sustainable exploitations and **ECODESIGN ISO 14006 certificate**.

■ REMARKABLE VALUES

1 – Legs covered with epoxy coating, bonding 2nd generation polymerized 200°C. Non-greasy treatments and nano-ceramics application to improve the coating so it becomes more resistance and long-lasting.

2 – Coating 80-90 micron thickness (it could be different as per the project requirements)

This covering guarantees the finish and maintenance of metal structures.

3 – Painting process:

Actiu painting plant has minimum environmental impact against the traditional industry processes.

Treatment is done by polarized coating and compacted with temperature. We get homogeneous and regular application with 98% of painting and the remaining 2% is used to produce other paints. Paints used are COVs free (Volatile Organic Components) which are very dangerous for the environment. All water used in the process is re-used, so we get zero dump. The process is free in heavy metal, phosphate, organic components and DQD (Biochemical demand of Oxygen). The program gives us an exact control of thickness, so it provides us with standard thickness (80-90 micron). Antibacterial finish

4 – ACTIU has **PEFC and FSC** certificate to proof that the wood used in our products comes from sustainable exploitations and **ECODESIGN ISO 14006 certificate**.

5 – **Optional** accessories fixed to the beams, modesty panels, screens, CPU holders or fixed pedestals.

■ TEXT REQUIREMENTS

ARKITEK

Architectonic style leg with vertical “**Y**” shape. It is manufactured of solid aluminium. In those points where the leg is more voluminous, is hexagonal shape (similar to a 6 side’s rhombus) which is only 3 sides in the leveler point and 4 sides in the support point.

The **leveler** is composed of a round aluminium plate 52 mm thickness.

The **point** where the leg, the top support and the beam fixing are merged together is an empty aluminum mass with triangle shape.

The **beam** is manufactured by extruded aluminium and it is composed by an inner flat bar 40 x 15 mm thickness to reinforce the frame. This is covered by another exterior plate with hexagonal shape.